



the art of tank gauging



For safety and precision

Preface

This document gives an introduction into modern tank gauging, how and where it can be used.

Accurate Servo- and Radar gauging, Hydrostatic Tank Gauging (HTG) and the Hybrid Inventory Management System (HIMS), combining the advantages of all systems, are described.

An uncertainty analysis of the tank inventory data is described and the results are used for a concise comparison of tank gauging systems. Uncertainties caused by the installation are listed and clarified. Current technologies employed in tank gauging, and future trends and possibilities of inventory systems are presented.

Copyright by:

Enraf B.V.

Delftechpark 39, 2628 XJ Delft

P.O. Box 812, 2600 AV Delft

The Netherlands

Tel.: +31 (0)15 2701 100

Fax: +31 (0)15 2701 111

Email: info@enraf.nl

<http://www.enraf.com>

Contents

| | |
|--|-----------|
| Preface | 2 |
| 1 An introduction to Tank Gauging | 4 |
| 1.1 What is Tank Gauging? | 4 |
| 1.2 Why Tank Gauging? | 4 |
| 1.2.1 Inventory control | 4 |
| 1.2.2 Custody transfer | 5 |
| 1.2.3 Oil Movement & operations | 5 |
| 1.2.4 Leak detection & Reconciliation | 6 |
| 2 Tank Gauging techniques | 7 |
| 2.1 Manual gauging | 7 |
| 2.2 Float and tape gauges | 7 |
| 2.3 Servo gauges | 7 |
| 2.4 Radar gauges | 8 |
| 2.5 Hydrostatic Tank Gauging | 9 |
| 2.6 Hybrid Inventory Measurement System | 10 |
| 3 Quantity assessment in Tank Gauging | 12 |
| 3.1 Level based quantity assessment | 12 |
| 3.2 Hydrostatic based quantity assessment | 13 |
| 3.3 Hybrid based quantity assessment | 13 |
| 4 Uncertainties in Tank Gauging | 14 |
| 4.1 Sources of errors | 14 |
| 4.2 Overview of uncertainties | 15 |
| 5 Safety | 16 |
| 5.1 Hazards of fire and explosions | 16 |
| 5.2 Lightning and Tank Gauging | 16 |
| 5.2.1 Suppression circuit | 16 |
| 5.2.2 Diversion circuit | 17 |
| 5.2.3 Grounding and shielding | 17 |
| 5.2.4 Field experience | 17 |
| 6 Developments in Tank Gauging Technology ... | 18 |
| 6.1 Servo gauges | 18 |
| 6.2 Radar gauges | 18 |
| 6.3 Temperature gauges | 19 |
| 6.4 Hydrostatic Tank Gauging | 20 |
| 6.5 Hybrid Inventory Measurement System | 20 |
| 6.6 Central Inventory Management System | 20 |
| 6.7 Interfacing to Host systems | 21 |
| 7 Future trends in Tank Gauging Technology | 22 |
| 8 Summary | 23 |
| 9 Literature | 23 |
| The complete system from one supplier | 24 |

1 An introduction to Tank Gauging

1.1 What is Tank Gauging?

Tank Gauging is the generic name for the static quantity assessment of liquid products in bulk storage tanks.

Two methods are recognized:

- A volume based tank gauging system.
Quantity assessment based on level- and temperature measurement.
- A mass based tank gauging system.
Quantity assessment based on hydrostatic pressure of the liquid column measurement.

Whatever method is used, a high degree of reliability and accuracy is of paramount importance when the data is used for inventory control or custody transfer purposes.

Refineries, chemical plants, terminals and independent storage companies make use of bulk storage tanks for storage of liquid or liquefied products:

- Common bulk storage tanks are above ground vertical cylindrical or spherical tanks.
- Vertical cylindrical tanks can be categorized as fixed roof tanks, with either a cone- or dome roof construction, or floating roof tanks.
- Underground storage facilities such as caverns are used in areas where the soil structure permits.



Fig. 1. Refineries make use of bulk storage tanks for which Tank Gauging is essential

Tank Gauging is essential to determine the inventory of liquid bulk storage tanks

In order to reduce the vapor losses of fixed roof tanks they can be fitted with internal floating roofs or screens.

Liquefied gasses are stored under pressure in spherical tanks, cylindrical vessels or under refrigerated or cryogenic conditions in specially designed, well insulated tanks.

Typical capacities of bulk storage tanks range from 1.000 m³ (6,300 bbl) to more than 120.000 m³ (755,000 bbl).

The value of the products stored in those tanks amounts to many millions of dollars.

A level uncertainty of only 1 mm (0.04 inch) or 0.01 % in a 10 m (33 ft) tall, 50.000 m³ tank (315,000 bbl), equals 5 m³ (31 bbl). Hence, accuracy is a prime requisite for good inventory management, however it is only one of the many aspects involved in tank gauging. Reliability to prevent product spills and safety of the environment and personnel are equally important.

The following listings show a number of requirements for Tank Gauging Systems.

General requirements for a Tank Gauging System

- Safety
- Accuracy and repeatability
- Reliability and availability
- Compatibility with operations
- Stand alone capabilities
- Operator friendly
- Low maintenance
- Easy to expand

Additional requirements

- First order failure detection
- Accepted for custody transfer and legal purposes (duties, royalties)
- Compatible with standards (API, etc)
- Interface to Host computer
- Software support
- Upgradability
- Service & spares support
- Acceptable Price/Performance ratio
- Vendors quality assurance procedures (ISO 9000)
- Manuals & documentation

1.2 Why Tank Gauging?

Tank Gauging is required for the assessment of tank contents, tank inventory control and tank farm management.

System requirements depend on the type of installation and operation.

The following types of operation, each having its own specific requirements, can be categorized:

- Inventory control
- Custody transfer
- Oil movement & operations
- Leak control & reconciliation

1.2.1 Inventory control

Inventory control is one of the most important management tools for any refinery, terminal or storage company.

Inventory represents a large amount of assets for each company. Tank inventory control is either based on volume or mass. However, neither volume nor mass is the sole solution for accurate and complete inventory control. Products received,

internal product transfers and delivered products of refineries, chemical plants and terminals are quite commonly measured in often incompatible volumetric or mass based units. Conversions from volume to mass and vice versa have to be frequently made, so that all measuring parameters like product level, water interface, density and temperature measurements are equally important. The combination of volume and mass as realized in hybrid systems provides the most attractive solution.

In-plant accuracy requirements for inventory control are often non-critical. The measurement uncertainties do not result in direct financial losses. Reliability and repeatability are much more important. Independent storage companies and terminals which strictly store and distribute products, owned by their customers, cannot operate without an accurate inventory control system. Such system should be very reliable, accurate and provide all inventory data.

1.2.2 Custody transfer

Many installations use their tank gauging system for the measurements of product transfers between ship and shore and/or pipeline transmission systems. A tank gauging system is a very cost effective and accurate solution compared to flow metering systems, especially when high flow rates are present and large quantities are transferred. When flow measuring systems are used, however, the tank gauging system offers a perfect verification tool.

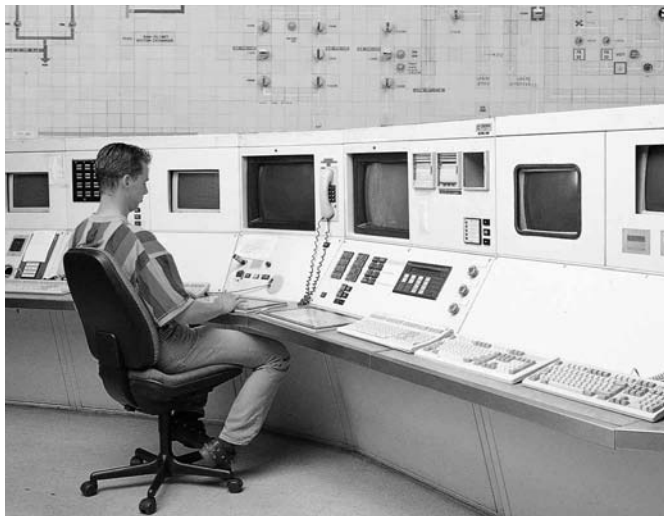

Fig. 2. Example of a central control room for a well-organized survey of all parameters

Where custody transfer or assessment of taxes, duties or royalties are involved, the gauging instruments and inventory control system are required to be officially approved and certified for this purpose.

In countries where such legal certification does not yet apply, verification of the measurements is often carried out by surveying companies. They generally use dip tapes, portable thermometers and sampling cans to measure level, temperature and density prior to, and after the product transfers. This is labor intensive and requires considerable time.

Surveyors use the same procedures to calculate volumes or mass as do modern tank gauging systems. Hence, the presence of a reliable, certified accurate tank gauging system facilitates their surveys and will reduce the turn around time. Another advantage is, that in those cases where the quantity of product transferred is determined on the basis of opening and closing tank measurements, some systematic errors are canceled out. Hence, the uncertainty of such transfer measurements is better than can be expected on the basis of uncertainties specified for tank inventory.

1.2.3 Oil Movement & operations

Generally tank content measurements for day to day operational use, for scheduling purposes and for blending programs do not require the same accuracy as custody transfer operations. However, measurement reliability and repeatability are important. Reliable level alarms are also a must to operate safely. A high degree of accuracy and reliability will allow operations to safely use the maximum tank capacity. Past experience indicates that a 5 % storage capacity gain can be achieved.



Fig. 3. High pressure Smart Radar for accurate level measurements

Oil Movement and operations generally have very strict equipment requirements. They specify compatibility with their supervisory control and management systems. Operations will use availability and easy maintenance as main criteria for selection of equipment. 'Cost of ownership' calculations, however, can provide excellent insights in the selection or evaluation of alternative instrument and measurement techniques. Still, the user of these type of calculations should be careful to use only correct and valid arguments. For example, including the price of a stilling well in a comparative study for level gauges can be inappropriate if such a well is already part of the tank construction. Additionally, better performance, in terms of higher accuracy and lower maintenance, needs to be valued.

For Oil Movement and operations, either mass or volume measurement techniques can be used. Volume can be derived from level only; mass can be measured directly by means of pressure transmitters. Additional information can be obtained by measuring vapor temperature and pressure. Density measurement can also be added, with accuracy's from 0.5 % up to 0.1 %. Whichever technique is selected, it should be compatible with the operations of all parties using the data from the tank gauging system. As stated earlier, plant management and control systems can facilitate Oil Movement and operations. Maintaining data integrity from the field to the receiving system is essential. A high degree of integration of the transmission of field-instruments is a pre-requisite. However, as long as a worldwide standard for digital communication is missing, different protocols will be in use.

1.2.4 Leak detection & reconciliation

For many decades the oil industry has been concerned with the financial consequences of oil losses. In recent years, there has also been an increased awareness of the industry's environmental impact. Pollution, caused both by liquid spills and atmospheric emissions, is an area of increased concern, and the industry has initiated programs to reduce the risks of environmental damage. Maintaining an accurate leak detection and reconciliation program is a necessity for any environmentally conscious tank farm owner.

At the fourth OIL LOSS CONTROL Conference in 1991, organized by the Institute of Petroleum in Great Britain, several leading authorities presented papers on nearly every aspect of loss control. Dr. E.R.Robinson, consultant to the IP Refining LOSS Accountability Committee, showed with a survey of 11 major UK refineries that an 'average' refinery could have yearly losses of 0.56 % of the total input quantity. An accurate, reliable tank gauging system helps to quantify and identify the source of these losses and offers the tools to prevent losses, or at least reduce them.

Another paper presented by Dr. J. Miles (SGS Redwood Ltd.) formulated an interesting approach to loss uncertainty assessment. Stock is mainly determined on basis of tank measurement, however, inputs and outputs can also be assessed via flow, (either volume or mass) and weighing bridge. Reconciliation of both measurements holds the key to reliable inventory control and effective loss control. A Hybrid Inventory Management System (HIMS), combines mass and volume based inventory systems, improving the reliability and reducing uncertainties of the overall balance.

Fig. 4. Storage tanks can be found everywhere, even in remote areas

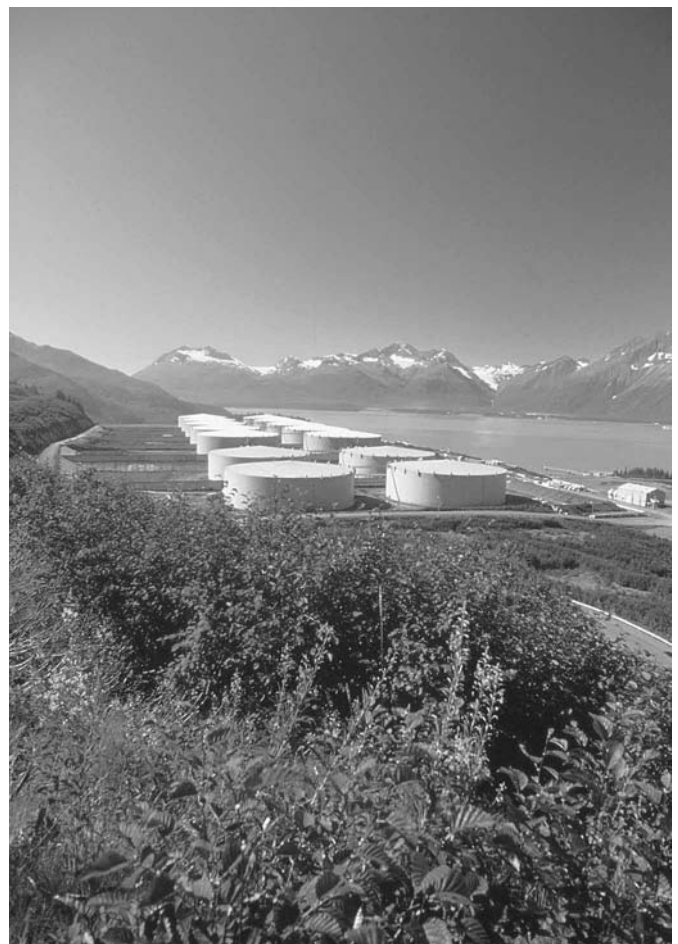

2 Tank Gauging techniques

Tank gauging has a long history! Since each user and every application has its own specific requirements, several measurement techniques and solutions to gauge tank contents are currently available.

2.1 Manual gauging

Tank gauging started with manual gauging, (Fig. 5) using a graduated diptape or dipstick. This technique is still used worldwide, and is today still the verification for gauge performance calibration and verification.



Fig. 5. Manual Gauging

The typical accuracy of a diptape used for custody transfer measurements is often specified as $\pm (0.1 + 0.1 L)$ mm [equal to $\pm (0.004 + 0.0012L')$ inch] for the initial calibration of new dip tapes. In the metric formula L is the level in meters and in the ft and inch formula L' is the level in ft. For tapes in use, the recalibration accuracy applies. This accuracy is twice the uncertainty of a new tape. But the tape uncertainty is not the only cause of error. Accurate hand dipping is a difficult task, particularly with high winds, cold weather, during night time or when special protection equipment has to be used. Additionally, a human error, of at least ± 2 mm (± 0.08 inch), has to be added to the tape readings. API Standard 2545 is dedicated completely to manual tank gauging.

Another disadvantage of manual tank gauging is that employees are often not allowed to be on a tank because of safety regulations, resulting in costly, long waiting times.

2.2 Float and tape gauges

The first float and tape gauges, also called "Automatic Tank Gauges", were introduced around 1930. These instruments use a large, heavy float in order to obtain sufficient driving force. Initially the float was connected via a cable to a balance weight with a scale and pointer along the tank shell indicating the level. Newer versions had the float connected, via a perforated steel tape, to a "constant" torque spring motor. The perforations drive a simple mechanical counter which acts as local indicator. Typical accuracy of a mechanical gauge is in the range of 10 mm ($\frac{1}{2}$ inch). Due to the mechanical friction in pulleys, spring motor and indicator, the reliability is poor. Remote indication is possible via an electronic transmitter coupled to the indicator. However, this will not improve the reliability or accuracy of the mechanical gauge.

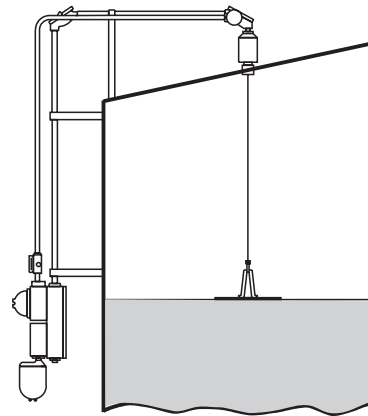

Fig. 6. Float and tape gauge

One of the major disadvantages with float driven instruments is the continuous sudden movement due to the turbulence of the liquid gauged. These movements, which can be rather violent, cause a continuous acceleration and deceleration of the drive mechanism, resulting in excessive wear and tear of the local indicator, transmitter and other devices coupled to the gauge. The reversing motions and accelerations cannot be followed by the indicating system and transmitter. Often the gear mechanism, driving the indicator and transmitter shaft, disengages, resulting in erroneous readings and de-synchronization of the transmitter. This leads to a considerable maintenance and lack of measurement reliability. In light of the present worldwide concern to prevent product spills, these gauges should no longer be used. Because of their low price, however, a large share of the world's tanks are still equipped with these instruments.

2.3 Servo gauges

Servo tank gauges (Fig. 7) are a considerable improvement over the float driven instruments. They were developed during the 1950s. In this gauge, the float is replaced by a small displacer, suspended by a strong, flexible measuring wire. Instead of a spring-motor, servo gauges use an electrical servo motor to raise and lower the displacer. An ingenious weighing system continuously measures the weight and buoyancy of the

displacer and controls the servo system. The motor also drives the integral transmitter.

Mechanical friction in the servo system, transmitter, local indicator and alarm switches has no effect on the sensitivity and accuracy of the gauge. Also, turbulence has no direct effect. An integrator in the servo control system eliminates the effects of sudden product movements. The gauge not only produces an average level measurement under turbulent conditions, but it also eliminates unnecessary movements and reduces wear and tear, greatly extending the operational life of the instrument.

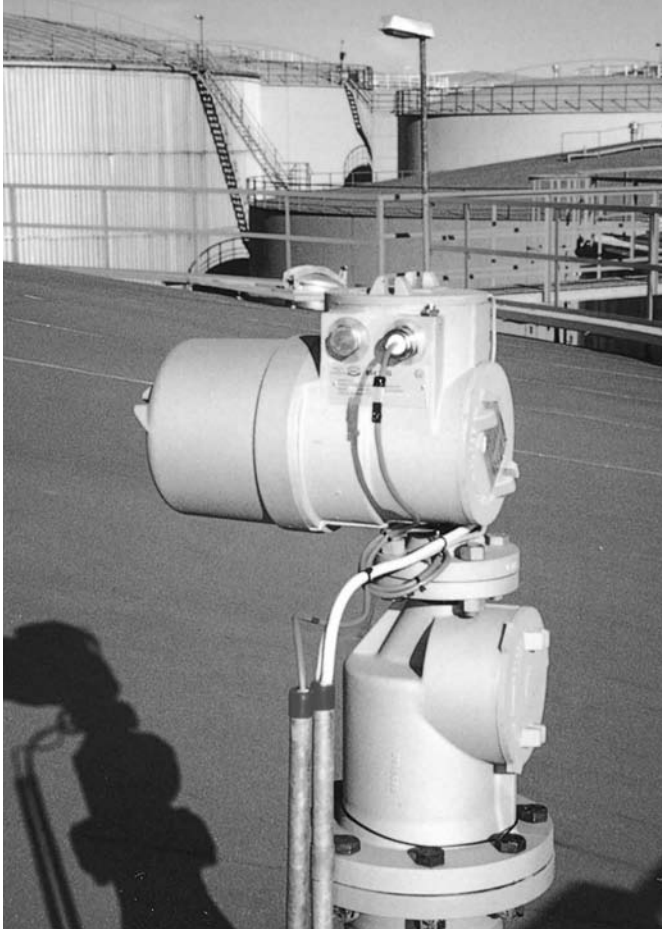

Fig. 7. Servo gauge

The original servo gauge does not look much like today's modern version. The instruments have evolved into highly reliable mature products, and are gradually replacing mechanical float gauges, cutting down on maintenance and improving on inventory results. Modern intelligent servo gauges have very few moving parts, resulting in long term reliability and accuracy. They also have a high degree of data processing power. The instruments do not merely measure the liquid level but are also capable measuring interface levels and product density.

Accurate, programmable level alarms are standard. Accuracy's of better than 1 mm (1/16 inch) over a 40 m (125 ft) range can be attained. The exceptional accuracy and reliability has resulted in the acceptance of the measurements and remote transmission, by Weights & Measures and Customs & Excise authorities in many countries.

2.4 Radar gauges

The use of radar to measure product levels in storage tanks is one of the most recent techniques.

Radar level gauges were developed in the mid sixties for crude carriers. The majority of these ships were equipped with mechanical float driven gauges. The level gauges were only used when the ship was ashore, loading or unloading. New safety procedures for tank washing with closed tanks during the return voyage, and the necessity to fill the empty tank space with inert gas, made non-intrusive measurements preferable. Accuracy was less important for the level measurement of the cargo tanks, since custody transfer and fiscal measurements used the certified level gauges or flow meters of the shore installation.



Fig. 8. Radar level gauge for free space measurement

Radar level gauges do not have moving parts and only an antenna is required in the tank. This results in very low maintenance cost. Although the investments costs are higher when compared to float gauges, the cost of ownership will be considerably lower.

The radar instruments use microwaves, generally in the 10 GHz range, for the measurement of the liquid level. The distance the signal has traveled is calculated from a comparison of transmitted and reflected signals. With tank gauging, relatively short distances have to be measured.

Electromagnetic waves travel with nearly the speed of light. Because of the short distances ranging from some centimeters (inches) to e.g. 20 m (66 ft) and the required resolution, a measurement based on time is almost impossible. The solution is to vary the frequency of the transmitted signal and measure the frequency shift between transmitted and reflected signal. The distance can be calculated from this frequency shift.

Now radar level gauges are available for product storage tanks found in refineries, terminals, chemical industries and independent storage companies. The absence of moving parts, their compact design and their non intrusive nature, result in low maintenance costs and make them very attractive. In order to achieve an accuracy ten times better than for use in marine applications, specific antennas and full digital signal processing have been applied. Older radar instruments were equipped with large parabolic or long horn antennas, whereas the modern radar level gauges use planar antenna techniques. These antennas are compact and have a much better efficiency, resulting in an excellent accuracy.



Fig. 9. Radar level gauge for stilling well measurement

Several antenna types are available to suit virtually every tank configuration:

- Free space propagation is the most common method and is used if the gauge is installed on top of a fixed roof tank. (Fig. 8)
- On floating roof tanks, the radar gauge can be installed on the guide pole. A specific radar signal (circular mode signal) is then guided via the inner shell of the guide pole or support pipe. (Fig. 9)
- Sensing the roof can be done by using a roof reflector and a radar level gauge with a free space antenna.
- Radar gauges can be also used on high pressure storage vessels. An isolation valve can be installed between the vessel and the instrument. Verification and calibration is possible while the instrument remains in service.

Accurate measurement on products with very low vapor pressures is possible with the latest radar gauging technique. Your supplier will be able to inform you in detail on this subject. Radar gauges are also a logical choice for tanks containing highly viscous products, like blown asphalt's, contaminating products and liquids that are very turbulent.

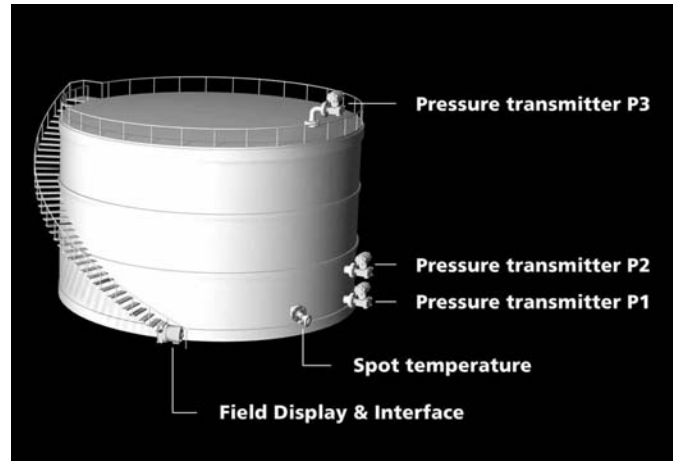

Fig. 10. HTG system

2.5 Hydrostatic Tank Gauging

Hydrostatic Tank Gauging (HTG) is one of the oldest techniques to measure the tank contents. In the process industry, level measurement using differential pressure transmitters is very common. Normally this method uses analog pressure transmitters, with a 1 % accuracy. However, so analog transmitters are not suitable for this purpose, inventory measurement requires a much better accuracy. Specially calibrated smart digital pressure transmitters are now available to provide much better accuracy.

The on-board microprocessor allows compensation for temperature effects and systematic transmitter deviations. HTG makes use of these accurate pressure transmitters for a continuous mass measurement of the tank contents. (Fig. 10)

Various HTG configurations are available:

- A simple HTG system can be built with only a single transmitter near the tank bottom (P1). The total mass can be calculated by multiplying the measured pressure by the equivalent area of the tank.
- By adding a second transmitter (P2) at a known distance from P1, the observed density (DENS. OBS.) of the product can be calculated from the pressure difference P1 - P2. The level can be calculated from the density and the P1 pressure.
- A P3 or top transmitter can be added to eliminate the effect of the vapor pressure on the P1 and P2 transmitters.

For pressurized tanks, HTG is less suitable. The large difference between the storage pressure and small hydrostatic pressure variations (turn down ratio), causes inaccurate results. Also the fitting of the transmitter nozzles on spheres is costly and often unacceptable.

On atmospheric tanks, HTG systems offer a 0.5 % uncertainty or better for the mass measurement. The accuracy of the HTG level measurement, although sufficient for the determination of the equivalent area, is 40 mm to 60 mm (1½ inch to 2 inch) and totally unacceptable for custody

Fig. 11. HIMS systems with Radar or Servo level gauge

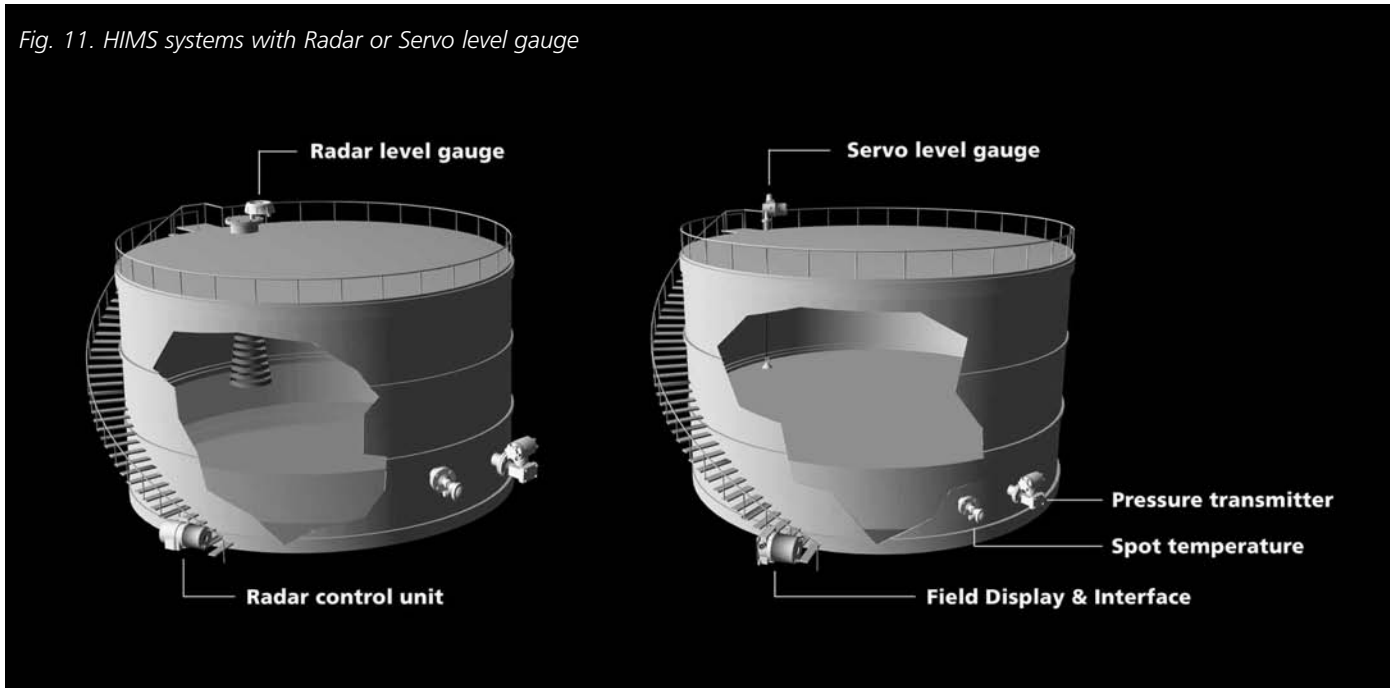

transfer or inventory assessment. Hence, many companies require the addition of a dedicated level gauge. A drawback of the HTG system is that its density measurement is only over a limited range near the bottom of the tank. If the liquid level is above the P2 transmitter, the calculated value is based on active measurements. However, if the level is under P2 there is no differential pressure measurement. This will be the case when the level is only 1.5 m to 2.5 m (6 ft to 8 ft) above the tank bottom. With many tanks, the density in the heel of the tank will be different from the density at higher levels. This density stratification has a devastating effect on the calculated values for level and volume. Since the level measurement of a HTG system is very inaccurate, it becomes worthless for any form of overfill protection. Secondary high level alarms are essential.

2.6 Hybrid Inventory

Measurement System Hybrid Inventory Measurement System (HIMS), combines the most modern level gauging techniques with Hydrostatic Tank Gauging. (Fig. 11 and 12) It utilizes an advanced Radar or Servo level gauge for accurate level measurement, with a smart pressure transmitter (P1) and a temperature measurement instrument. On non atmospheric tanks, a second transmitter for the vapor pressure compensation is required.

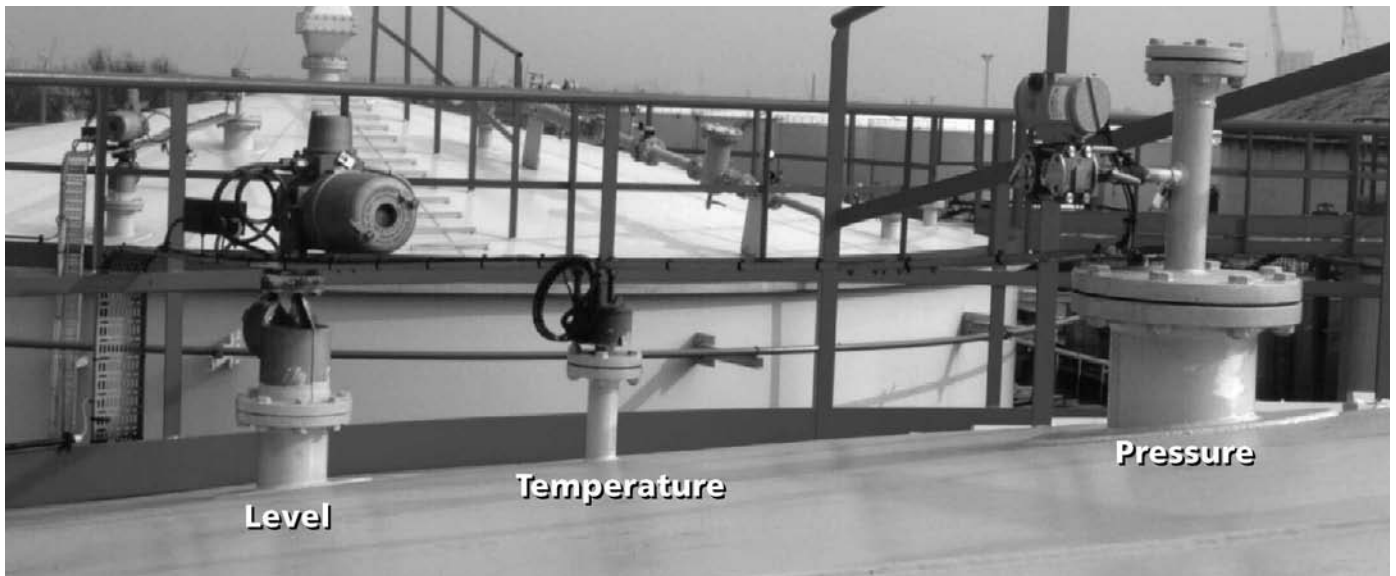

Fig. 12. Upper part of a HIMS installation

The level measurement is the basis for an accurate volume inventory calculation. The pressure measurement, combined with the level, provides a true average density measurement over the entire product level height. This average density is used for the mass assessment. The temperature is used to calculate standard volumes and densities at reference temperatures.

Advanced servo gauges and radar gauges can be provided with an interface board that communicates directly with the smart pressure transmitter. The result is a unique Level Temperature Pressure and very complete measurements providing level, interface levels, product-water interface levels, average density, average temperature, vapor temperature and alarms.

Existing installations with advanced Radar or Servo level gauges can, in most cases, easily be extended to become a HIMS system.

HIMS is often called 'The best of both worlds', providing the best of level gauging combined with the best of hydrostatic gauging.



Fig. 12b. Example of a Temperature Measurement Instrument (HIMS installation)

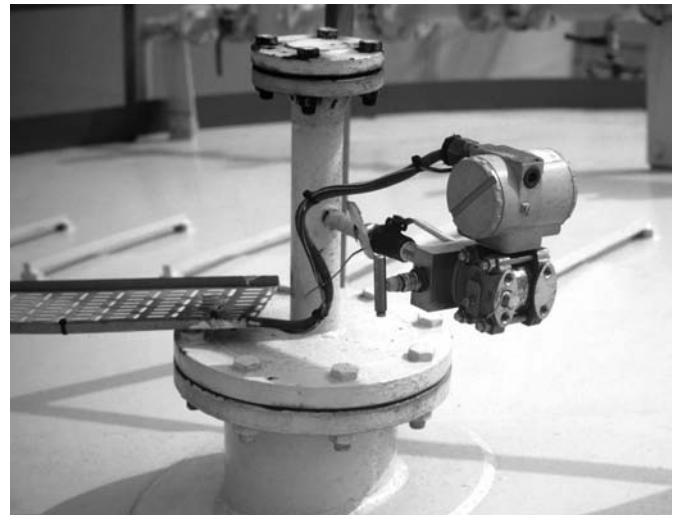

Fig. 12c. Smart Pressure Transmitter (HIMS installation)

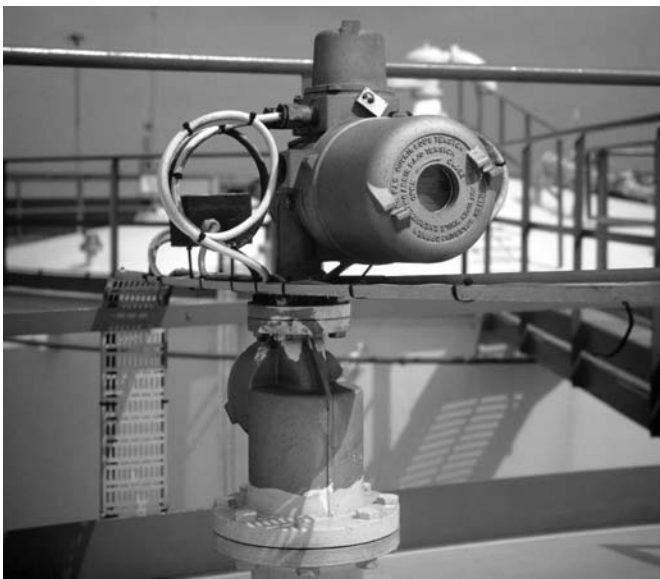

Fig. 12a. The Servo Level Gauge as part of a HIMS installation

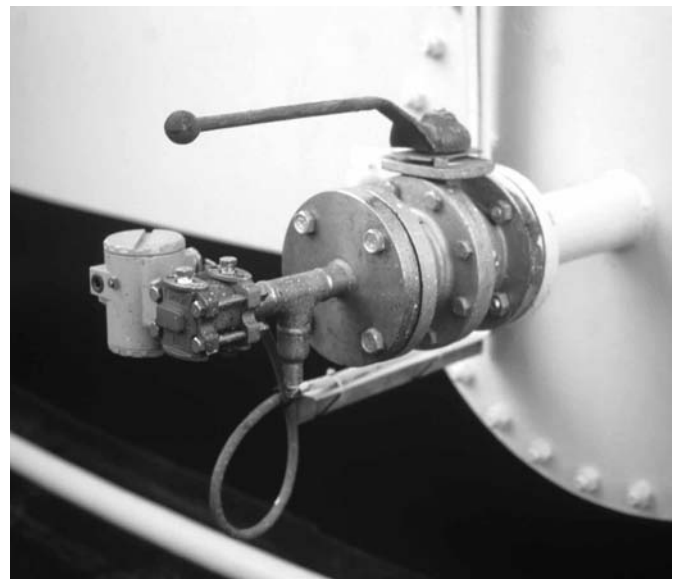

Fig. 12d. Example of a smart Pressure Transmitter on the side of a tank (HIMS installation)

3 Quantity assessment in Tank Gauging

The uncertainties of quantity assessment of a tank gauging system depend on the measuring uncertainties of the installed instruments, Tank Capacity Table (T.C.T.) and installation.

Level gauging instruments measure the liquid level in the tank. Pressure transmitters measure the hydrostatic pressure of the liquid column. Both level and pressure are primary functions for the calculation of volume and mass respectively.

Hybrid systems, such as HIMS, use both inputs in one system. Conversions from volume to mass or vice versa are made using density and temperature as secondary inputs. The density input may be obtained from an outside source, such as a laboratory, or may be measured in the tank by using pressure transmitters or servo density. The temperature input is obtained from a temperature measuring system in the tank.

How the individual errors influence a mass or volume uncertainty depends on the type of quantity assessment.

3.1 Level based quantity assessment

Fig. 13 shows how the quantity assessment in a conventional level (volume) based system is accomplished.

The tank references liquid level, liquid temperature and liquid

density are the relevant parameters.

- Level is measured using a Radar or Servo level gauge.
- Temperature is measured using a spot or average temperature sensor.
- Density at reference temperature is obtained from a laboratory analysis of a grab sample.
- The Gross Observed Volume (G.O.V.) is derived from level and the Tank Capacity Table (T.C.T.).
- The Gross Standard Volume (G.S.V.) is calculated from the G.O.V., corrected with the Volume Correction Factor (V.C.F.).
- The V.C.F. is derived from the temperature measurement using the ASTM Table 54 and the density at reference temperature (DENS. REF.).
- The total MASS is calculated from the G.S.V. multiplied by the density at reference temperature (DENS. REF.).

The MASS of the product can also be calculated from the Net Standard Volume, as the G.O.V. minus sediment contents and water.

Major causes for uncertainties are the temperature assessment and the Tank Capacity Table. Additional functionality can be added to enhance the total performance, e.g. vapor pressure and water interface measurement.

Fig. 13. Level based quantity assessment

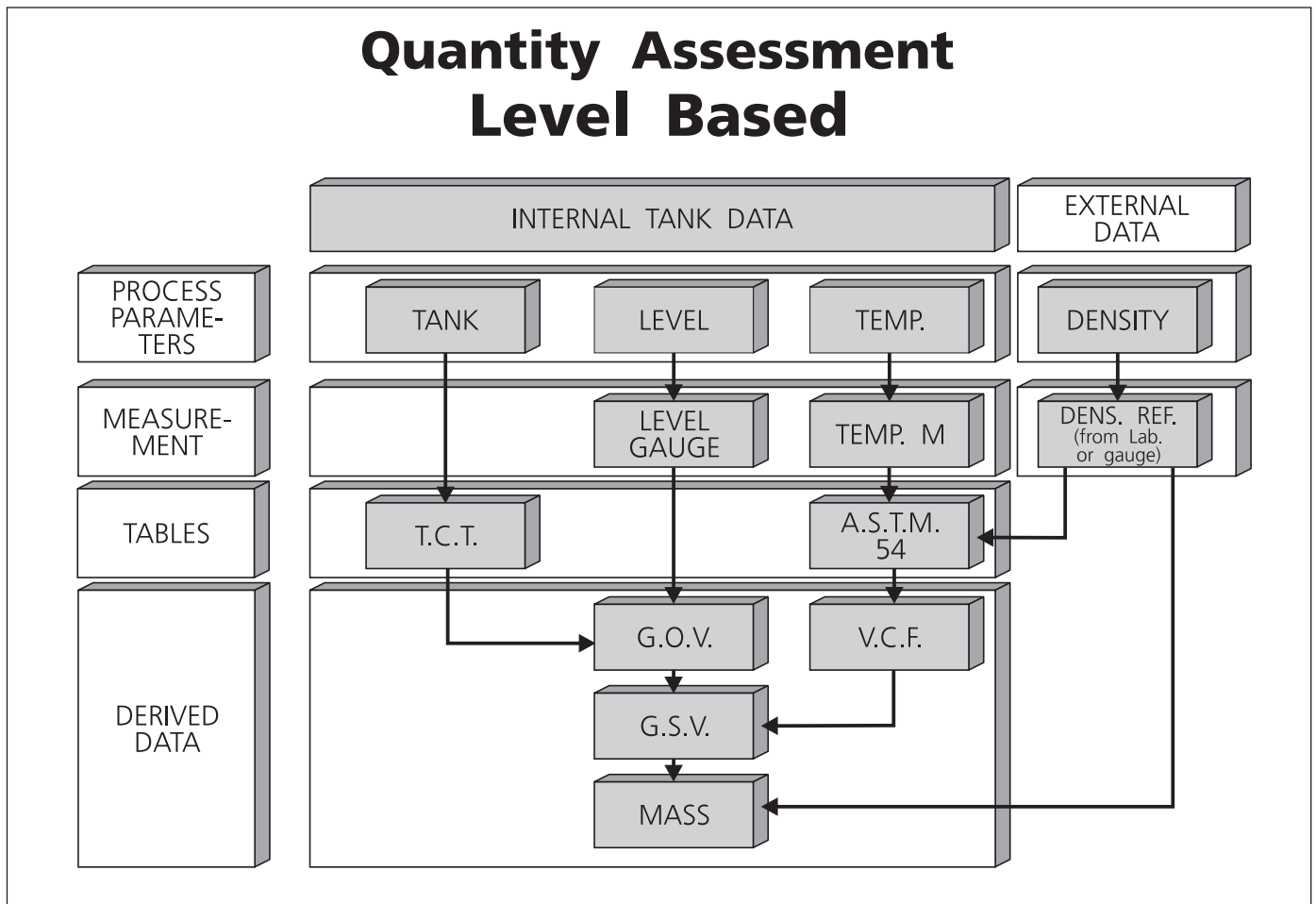

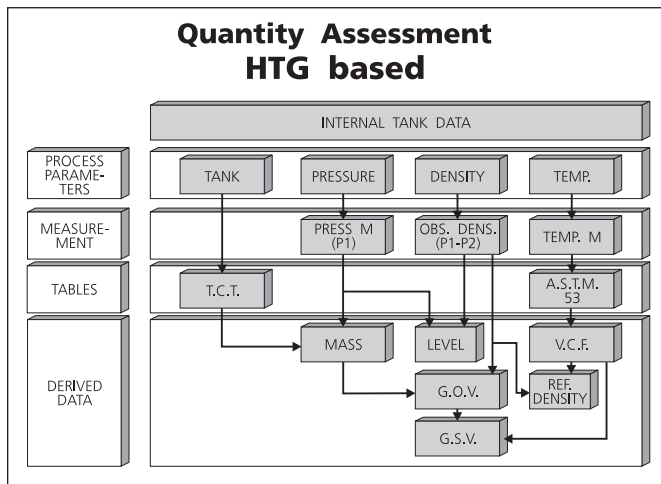

Fig. 14. HTG based quantity assessment

3.2 Hydrostatic based quantity assessment

The quantity assessment of a HTG based system is shown in Fig. 14. The tank references, hydrostatic liquid pressure, liquid density and liquid temperature are the relevant parameters.

- Pressure M is measured via pressure transmitter P1.
- The observed Density (DENS. OBS.) is measured using pressure transmitters P1 and P2.
- Temperature can be measured for G.S.V. calculations with a temperature sensor.
- The MASS is directly calculated from the equivalent area and the PI (PRESS. M) transmitter. The equivalent area is obtained from the tank Capacity Table (T.C.T.).
- The G.O.V. is derived from MASS and the observed density.
- The observed density is derived from the differential pressure measurement of P1 - P2 and the distance between both transmitters. The V.C.F. is derived from the temperature measurement using the ASTM Table 54 and the density at reference temperature (DENS. REF.).
- The G.S.V. is calculated from the G.O.V., corrected with the V.C.F.
- The V.C.F. is derived from the temperature measurement using the ASTM Table 54 and the density at reference temperature (DENS. REF.).
- The level is derived from the pressure (PRESS M) and density (DENS. OBS.) measurement obtained from P1 and P2.
- The density at reference temperature (DENS. REF.) is derived from the observed density (DENS. OBS.), however corrected with the V.C.F.

Major uncertainties in an HTG system are caused by the T.C.T., the pressure transmitters and calculations using an incorrect density value as a result of non-homogeneous products

Variations of the temperature do not influence the mass accuracy. The temperature is required for the calculation of the density under reference conditions and G.S.V.

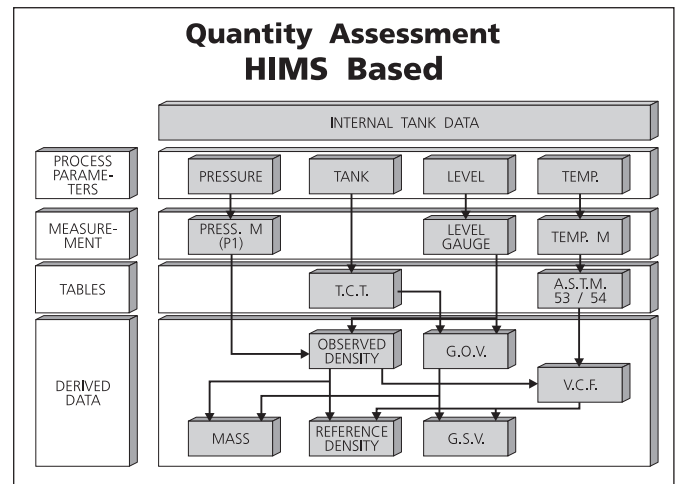

Fig. 15. HIMS based quantity assessment

3.3 Hybrid based quantity assessment

The quantity assessment of a HIMS based system is shown in Fig. 15.

The hydrostatic liquid pressure, tank references, liquid level and liquid temperature are the relevant parameters.

- The hydrostatic pressure is measured using pressure transmitter P1.
- Level is measured by an advanced Radar or Servo level gauge.
- Temperature is measured using a spot temperature sensor or average temperature sensor.

The system is basically the same as the Level based system, however, the density is derived from the hydrostatic pressure (PRESS M) measured by P1 and the height of the liquid column on P1.

- The G.O.V. is derived from level and the Tank Capacity Table (T.C.T.).
- The G.S.V. is calculated from the G.O.V. and corrected with the V.C.F.
- The MASS, however, is directly calculated from the G.O.V. and DENS. OBS. from PRESS. M measured by P1.
- The DENS. REF. is calculated from DENS. OBS. corrected with the V.C.F.
- The V.C.F. in this case is derived from the temperature measurement using the ASTM Table 54 and the DENS. OBS.

HIMS provides, as an additional benefit, a highly accurate continuous average density measurement.

The average observed density is determined over the entire level height! This is a unique feature because all other systems determine the density at one or more specific levels or over a limited range of 2 m to 3 m (6.6 ft to 5 ft) only.

4 Uncertainties in Tank Gauging

In order to compare the different quantity assessment systems, it is necessary to analyze all parameters affecting the final uncertainty of each gauging system.

Instrument data sheets usually only state accuracy's under reference conditions. Mass and volume accuracy's derived from these data are often too optimistic. For correct interpretation of data sheets and justification of the choice of instruments, errors caused by the installation should also be taken into account. This can be difficult. Even within international organizations dealing with standardization, much time is spent to establish the correct way to calculate or determine final uncertainties.

An uncertainty analysis for tank gauging was developed in order to get a better understanding of the mechanisms and parameters involved. On the basis of this analysis, a number of graphs and data tables have been produced, illustrating the uncertainties of the measurement systems dealt with in this document. Analysis was done both for inventory and batch transfers. All uncertainties are expressed as relative values, i.e. as percentages of the inventory or the quantity transferred, as is customary in loss control and custody transfer.

The comparison makes use of generic specifications of uncertainties for tank gauging equipment, storage tanks and installation. The data used are assumed to be manufacturer independent.

4.1 Sources of errors

The overall uncertainty in the quantity assessment is the combined result of all uncertainties of each single parameter in

Fig. 16. Major sources of errors

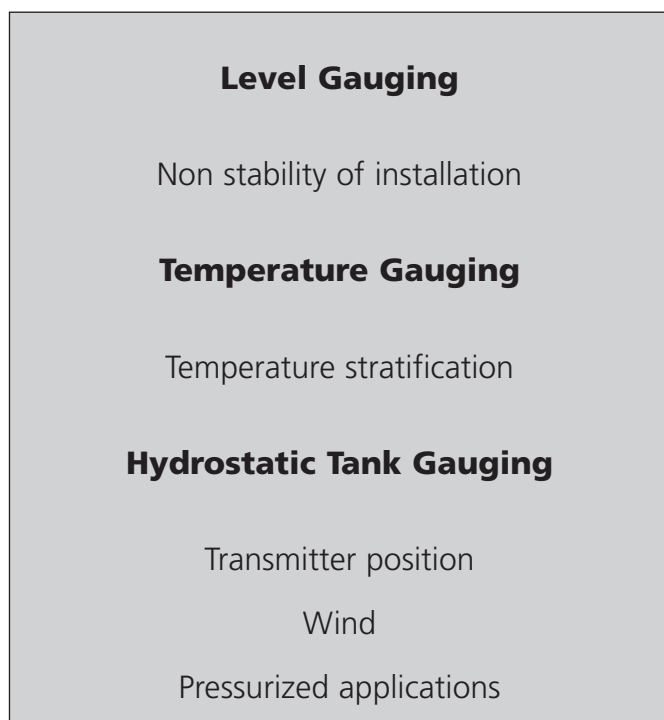

the calculation. In order to obtain the optimal accuracy of a specific gauge, careful installation is required. This applies to all types of gauges. Fig. 16 shows the major sources of errors in Tank gauging.

- Bulk storage tanks are not designed to serve as measuring vessels. Their actual shape is influenced by many factors. Computerized compensation for some of these effects is possible, provided the effects are known and reproducible. For the best accuracy obtainable with level measuring devices, a stable gauging platform is a prerequisite. The use of a support pipe is an available and known technique, and is already present on many tanks, with and without floating roofs. The presence of a such a pipe is an advantage that makes the best accuracy possible when choosing instruments in a revamp project.

For radar gauges, existing pipes can be used to provide mechanical stability. Circular mode antennas are required when installation on a pipe is foreseen. On high pressure tanks, installation of an insert with reference pins is recommended.

- Temperature is an often underestimated measuring parameter. An accurate average temperature measurement is essential to achieve accurate inventory calculations. Spot measurements are not useful when the product temperature is stratified.
- Equipment used in HTG systems are installed external to the tank. With existing tanks hot tapping, an installation method while the tank remains in service, may be the solution when company regulations permit. This technique is fully developed, but there are different opinions on the safety aspects. The P1 transmitter must be installed as low as possible, but above maximum water and sediment level. It is important to realize that the product below the P1 nozzle is not actually measured. This restriction severely limits the minimum quantity that can be measured for custody and tax purposes.

A study performed by the Dutch Weight & Measures showed that wind can cause errors as much as 0.2 % on a 10 m (33 ft) high tank. On fixed roof tanks, compensation for this error can be accomplished with an external connection between P1 and P3. High nominal operation pressures encountered in spheres and bullet type vessels, require specially developed transmitters. The measurement of the small signal superimposed on the high pressure reduces the accuracy.

4.2 Overview of uncertainties

Fig. 17 and 18 show respective overviews on uncertainties on inventory and batch transfer for level based systems (Servo / Radar), HIMS and HTG systems.

| Inventory | | Level Servo/Radar | | HIMS | | HTG | |
|--------------------------------|------|----------------------|--------|--------|------|------|--------|
| [m] | [ft] | Mass | G.S.V. | G.S.V. | Mass | Mass | G.S.V. |
| 20 | 66 | 0.12 | 0.06 | 0.06 | 0.04 | 0.04 | 0.43 |
| 10 | 33 | 0.12 | 0.07 | 0.07 | 0.08 | 0.08 | 0.41 |
| 2 | 6.5 | 0.13 | 0.08 | 0.08 | 0.08 | 0.40 | 0.34 |
| Inventory uncertainties in [%] | | | | | | | |

Fig. 17. Overview of inventory uncertainties

| Transfer | | Level Servo/Radar | | HIMS | | HTG | |
|-------------------------------------|--------|----------------------|--------|--------|------|------|--------|
| [m] | [ft] | Mass | G.S.V. | G.S.V. | Mass | Mass | G.S.V. |
| 20-18 | 66-60 | 0.31 | 0.30 | 0.30 | 0.28 | 0.28 | 3.09 |
| 4-2 | 13-6.5 | 0.14 | 0.10 | 0.10 | 0.28 | 0.28 | 0.61 |
| 20-26 | 66-6.5 | 0.11 | 0.04 | 0.04 | 0.03 | 0.03 | 0.47 |
| Batch transfer uncertainties in [%] | | | | | | | |

Fig. 18. Overview of batch transfer uncertainties

Note: For level based systems the density is obtained from the laboratory analysis of a grab sample; the uncertainty is assumed to be $\pm 0.1\%$.

Fig. 19. A refinery



5 Safety

5.1 Hazards of fire and explosions

The majority of tank gauging instruments are installed on tanks containing flammable products. The instruments on such tanks or in the surrounding hazardous area must be explosion proof. Circuits entering the tank atmosphere, like temperature measuring systems, should be intrinsically safe. In the past, each country had its own safety standards, but an international harmonization of standards has become a reality.

The European CENELEC standards and the American NFPA standards are acceptable in many countries. Safety, i.e. the fact that the explosion proof or intrinsically safe construction meets the standards, must be certified by an independent approval institute. Well known institutes are PTB (Germany), Factory Mutual Research (USA), SAA (Australia), JIS (Japan) and CSA (Canada).

The better tank gauging instruments do not just meet the safety standards but exceed them by anticipating future safety requirements as well. Such requirements include the exclusion of aluminum inside storage tanks (zone O), the limitation of the kinetic energy of moving parts of a gauge to values far less than could cause ignition.

5.2 Lightning and Tank Gauging

Lightning can cause hazardous situations, and measures should be taken to protect the tank installation and tank gauging system against these hazards. Modern tank gauging systems contain many electronic circuits. Their position on top of storage tanks makes this equipment more vulnerable to lightning damage than any other type of industrial equipment. Today's communication systems linking all field equipment via one network increase the probability of possible damage to the equipment as the networks spread over increasingly larger areas. With high reliability as availability, one of the prime requirements of modern tank gauging equipment, there is a need for well designed, field proven lightning protection methods. Fig. 20 shows a tank gauge under high voltage test.

In tank farms, lightning causes a direct potential difference between the gauge, grounded to the tank at one end, and the central receiver at the other. This results in a potential difference between cable and gauge or cable and receiver. This difference between equipment and cable tries to equalize itself and searches a low impedance path between the circuitry connected to the cable and the ground. As soon as the potential difference exceeds the isolation voltage, a breakdown occurs between the electronics and the ground. Additionally, transient currents will be induced in adjacent components and cabling.

The currents flowing through the electronics cause disastrous effects. Every semiconductor which is not sufficiently fast or capable of handling the currents for even a short period will be destroyed.

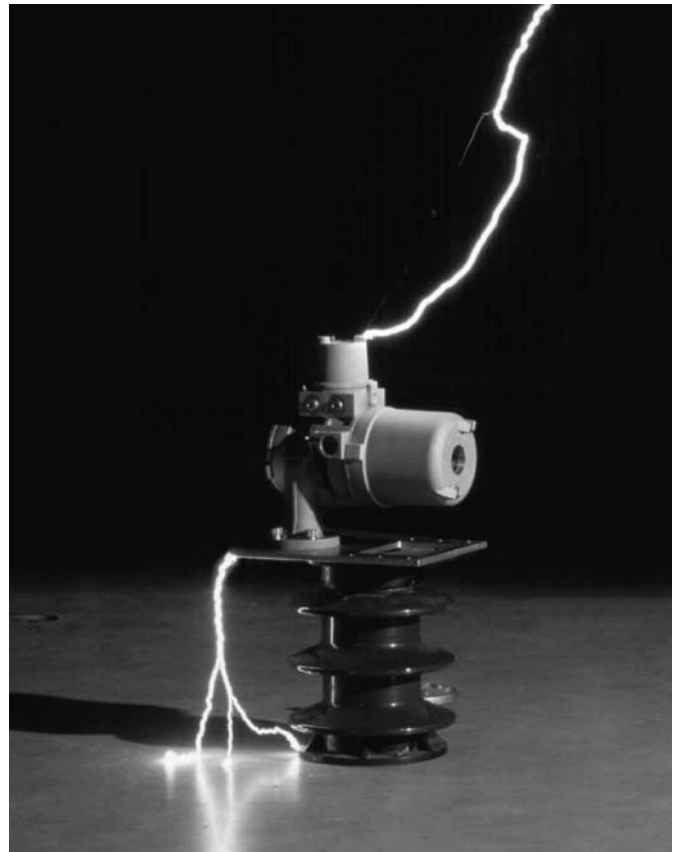

Fig. 20. Tank gauge under high voltage test

Two basic techniques are used for minimizing the damage due to lightning and transients: Suppression and Diversion.

5.2.1 Suppression circuit

By means of special circuits on all incoming and outgoing instrument cables, it is possible to suppress the magnitude of the transient appearing at the instrument. (Fig. 21)

A gas discharge tube forms the kernel.

Gas discharge tubes are available for voltage protection from 60 V up to more than 1000 V and react in several microseconds, after which they form a conducting ionized path. They provide no protection until they are fully conducting.

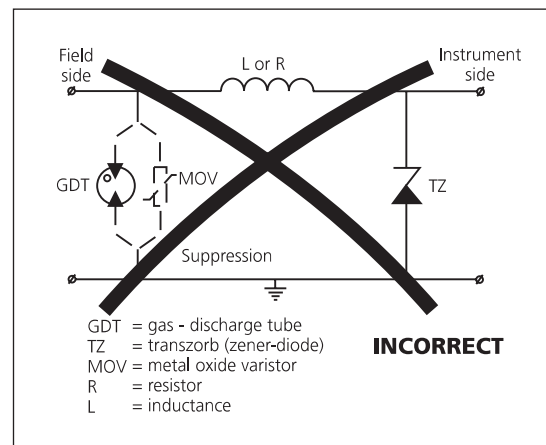

Fig. 21. Suppression circuit

A transorb or varistor, in combination with a resistor and preferably an inductor can be added to improve the protection. These semiconductors react within a couple of nanoseconds and limit the voltage. A major problem is that each time a transient suppressor reacts, it degrades. Reliability is therefore poor, rendering this type of device unsuitable for critical applications like tank gauges.

5.2.2 Diversion circuit

Diversion (Fig. 22) is a much more reliable technique and better suited for lightning protection of electronic tank gauging instruments. Modern protection uses diversion combined with screening and complete galvanic isolation. It is a technique in which the high voltage spikes are diverted rather than dissipated.

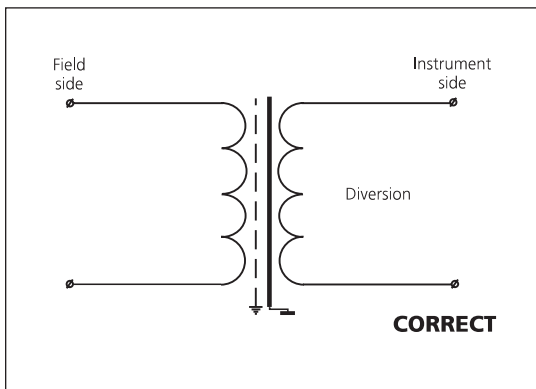

Fig. 22. Diversion circuit

Specially developed isolation transformers are used for all inputs and outputs. They have two separate internal ground shields between primary and secondary windings and the transformer core. External wiring is physically separated from internal wiring and ground tracks are employed on all circuit boards to shield electronics. Unfortunately this protection method is not suitable with d.c. signals. In this case a conventional transient protection, enhanced with an additional galvanic isolation, is used.

5.2.3 Grounding and shielding

Proper grounding and shielding will also help protect instruments and systems connected to field cabling against damage by lightning. The possible discharge path over an instrument flange (e.g. of a level gauge) and the corresponding mounting flange should have a nearly zero resistance to prevent built-up of potential differences. A poor or disconnected ground connection may cause sparking and ignite the surrounding product vapors.

5.2.4 Field experience

The diversion method described for internal lightning protection has been in use for more than 15 years, with approximately 50.000 installed instruments. Almost 100 % of this equipment is installed on top of bulk storage tanks, and interconnected via wide area networking.

A large number of installations are situated in known lightning prone areas. To date, only a few incidents in which lightning may have played a decisive role have been experienced. The amount of damage was always limited and could be repaired locally at little expense. Before this protection method was applied, more extensive lightning damage had been experienced.



Fig. 23. Typical bulk liquid storage tanks

6 Developments in Tank Gauging Technology

6.1 Servo gauges

Modern servo gauges are already members of the sixth generation. (Fig. 24) They use modern embedded micro-controllers, minimizing the total amount of electronics. Advanced software development tools and higher order programming languages provide reliable operation. Fuzzy control algorithms improve interaction of mechanics and electronics, reducing the number of mechanical parts.

Current Advanced servo Tank Gauges (ATG) have less than 5 moving parts.

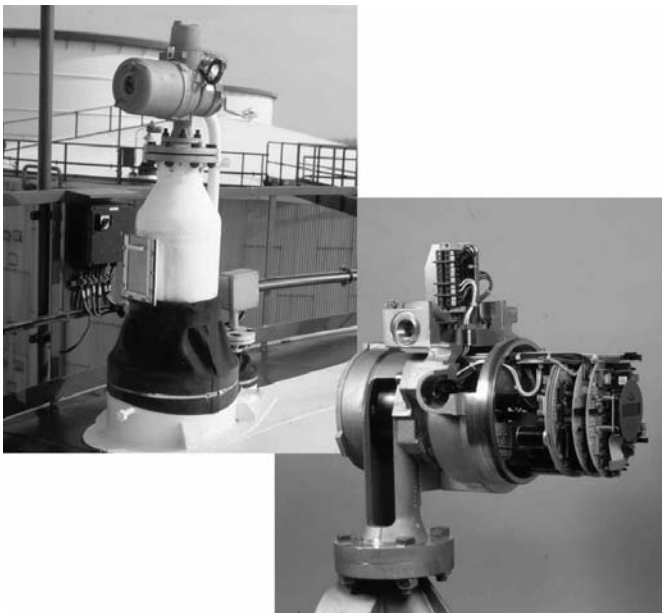

Fig. 24. Advanced Technology servo Gauge

Main features of an advanced technology servo gauge are:

- Low operating cost.
- Typical MTBF of more than 10 years.
- Low installation cost, especially when used to replace existing servo gauges.
- A standard accuracy of 1 mm (0.04 inch).
- Software compensation for hydrostatic tank deformation, making support pipes no longer a must for accurate measurement.
- Full programmability for easy set-up and simple maintenance without having to open the instrument.
- Compact and Lightweight construction requiring no hoisting equipment.
- Possibilities for installation while the tank stays in full operation.
- Continuous diagnostics to provide a maximum of reliability and availability.
- Water-product interface measurement for time scheduled water measurement.
- Spot- and average product density measurement.

- Interfacing to other smart transmitters, e.g. for product and vapor temperature, and pressure via a digital protocol, including average density support.

The strict German legislation currently accepts advanced servo gauges as a single alarm for overfill protection!

6.2 Radar gauges

Radar gauges play an important role in tank gauging. (Fig. 25 and 26) Their non-intrusive solid state nature makes them very attractive. The accuracy of the newest generation radar gauge meets all requirements for custody transfer and legal inventory measurements.



Fig. 25. Radar level gauge with Planar antenna Technology

Reliability is high and maintenance will be further reduced. The on-board intelligence allows for remote diagnosis of the total instrument performance. The compact and lightweight construction simplifies installation without the need for hoisting equipment. Installation is possible while the tank stays in full operation. Current developments are aimed at more integrated functions. Improved antenna designs, full digital signal generation and processing offer better performance with less interaction between tank and radar beam.

Main features of the new generation Radar level gauge are:

- NO moving parts.
- Very low maintenance cost.
- Low operational cost.
- Non-intrusive instrument.
- Low installation cost.
- Typical MTBF of more than 60 years.
- Low cost of ownership.
- Modular design.
- A standard accuracy of 1 mm (0.04 inch).
- Software compensation for the hydrostatic tank deformation, making support pipes no longer a must for accurate measurement.
- Full programmability for easy set-up and verification facilities.
- The compact and lightweight construction eliminating the need for hoisting equipment installation possibilities while the tank stays in operation.
- Continuous diagnostics providing a maximum of reliability.
- Water-product interface measurement using digital integrated probe.
- Density measurement via system integrated pressure transmitter (HIMS).
- Interfacing to other transmitters, e.g. for product and vapor temperature, and pressure via digital protocol.



Fig. 26. Radar level gauge for high pressure applications

6.3 Temperature gauging

Accurate temperature measurement is essential for level based tank gauging systems.

Spot temperature elements are widely accepted for product temperature assessment on tanks with homogenous products. Installation is simple and the reliability is good. The graph of Fig. 27 shows that spot measurements are unsuitable to accurately measure the temperature of products which tend to stratify. The effects of temperature stratification can be neglected only for light products, mixed frequently.

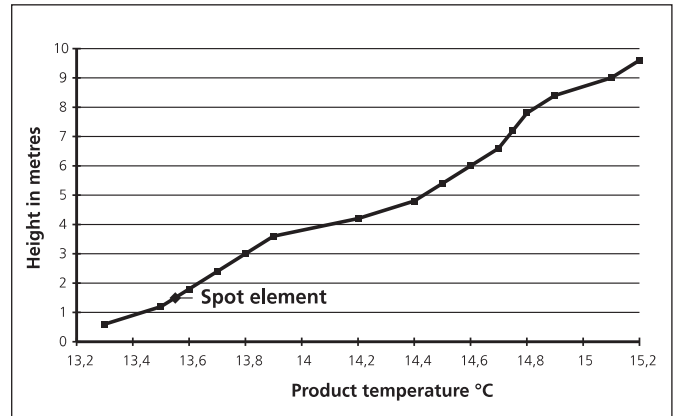

Fig. 27. Temperature stratification in a storage tank

In general, average temperature measuring elements are used in case of temperature stratification.

The latest development is the Multi-Temperature Thermometer (MTT) shown in Fig. 28 which utilizes 16 thermosensors evenly distributed over the maximum possible liquid height. A very accurate class A Pt100 element at the bottom is the reference. Accuracy's of better than 0.05 °C (0.08 °F) are possible. The elements can also be individually measured to obtain temperature profiles and vapor temperatures.

MTT's are available with both nylon and stainless steel protection tubes. It provides a rugged construction suitable for the harsh environments of a bulk storage tank.

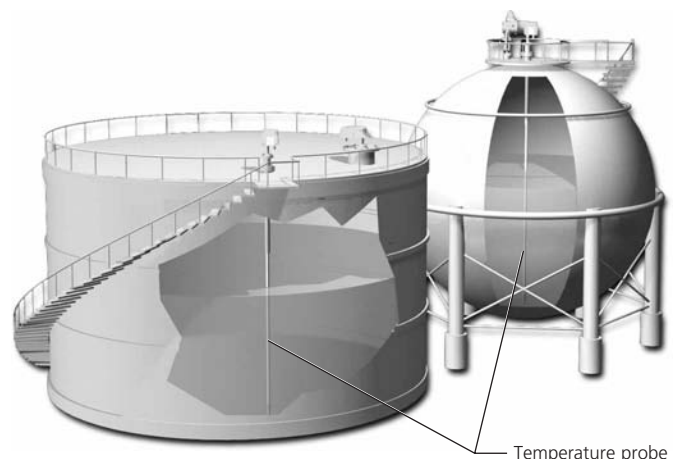

Fig. 28. Average temperature an important parameter

Another type of average temperature measuring element is the Multi-Resistance Thermometer (MRT). Its operation is based on a number of copper-wire temperature sensing elements of different lengths. Average temperature measurement is achieved by measuring the longest fully-immersed resistance thermometer chosen by a solid state element selector. A drawback of MRT's is the delicate construction of the elements. The very thin copper wire used makes the device susceptible for damage, especially during transport and installation.

6.4 Hydrostatic Tank Gauging

Recent developments of smart transmitters opened a new era for Hydrostatic Tank Gauging (HTG).

The development of smart pressure transmitters with microcomputers made Hydrostatic Tank Gauging feasible. Only a couple of years ago, high accuracy pressure transmitters were still rare and quite expensive. Several manufacturers now offer 0.02 % accuracy transmitters. Digital communication by means of de facto standards as the HART™ -protocol, permits simple interfacing to almost any transmitter. This wide choice simplifies selection for specific applications, and allows the user to choose his own preferred transmitter. The inherent standardization for the end user reduces the cost of maintenance.

6.5 Hybrid Inventory Measurement System

Hybrid Inventory Measurement Systems (HIMS) are also based on the integration of smart pressure transmitters. Modern level gauges, either servo or radar, provide the possibility for direct interfacing to smart pressure transmitters. HIMS opens the ideal route to total tank inventory systems, measuring all tank parameters via one system.

6.6 Central Inventory management system

The interface to the operators and/or the supervisory control and management system is the tank gauging inventory management system. (Fig. 29) These high speed systems collect the measurement data from all tank gauging instruments, continuously check the status of alarms and functional parameters and compute real time inventory data such as volume and mass.

The hardware used is generally off-the-shelf personal or industrial computers loaded with dedicated inventory management software. It is this software, together with the reliability and integrity of the field instrumentation that determines the performance and accuracy of the inventory management system. All field instruments, regardless of age or type, should communicate via the same transmission bus. Product volumes and mass should be calculated the same way as do the owner appointed authorities and surveyors.

The system software should store the tank table parameters, calculate observed and standard volumes, correct for free water and, if applicable, correct for the floating roof immersion. The Gross Standard Volume (GSV) calculations must be in

accordance with API, ASTM and ISO recommendations implementing tables 6A, 6B, 6C, 53, 54A, 54B, 54C and 5.

The quality of the inventory management system can be evidenced from the availability of Weights 81 Measures or Customs & Excise approvals. Inventory management systems can have their own display consoles or can make all data available for a supervisory system.

Networked systems are available when required. Apart from a large number of inventory management functions, the system can also control inlet and outlet valves of the tanks, start and stop pumps, display data from other transmitters, provide shipping documents, provide trend curves, show bar graph displays, perform sensitive leak detection, calculate flow rates, control alarm annunciation relays, perform numerous diagnostic tasks and much more. For examples of display formats of an inventory management system see Fig. 30.

The operator friendliness of the system is of paramount importance. The better and more advanced systems have a context-sensitive help keys that make the proper help instructions immediately available to the operator.

Fig. 29. Central inventory management system



6.7 Interfacing to Host systems

The receiving systems can also be equipped with host communication interfaces for connection to plant management systems i.e.:

- Distributive Control Systems (DCS),
- Integrated Control Systems (ICS),
- oil accounting systems,
- etc.

Protocols have been developed in close cooperation with the well known control system suppliers.

These are needed in order to transmit and receive the typical tank gauging measuring data. Standard MODBUS and other protocols are available for smooth communication between tank inventory systems and third party control systems. Modern DCS or other systems have sufficient power to handle inventory calculations, but often lack the dedicated programming required for a capable inventory management.

Tank inventory management systems, specially developed for tank farms and equipped with suitable host links, will have distinct advantages.

- It frees the host system supplier from needing detailed knowledge of transmitter and gauge specific data handling.
- Maintaining a unique database, with all tank related parameters in one computer only, is simple and unambiguous.
- Inventory and transfer calculation procedures outside the host system are easier for Weight and Measures authorities.
- Implementation of software required for handling of new or more tank gauges can be restricted to the tank gauging system. This will improve the reliability and availability of the host system.

Connecting all field instruments via one fieldbus to the supervisory system, DCS or Tank Gauging System is advantageous for operations. It simplifies maintenance and service, and allows fast replacement of equipment in case of failure.

Fig. 30. Display formats of an inventory management system

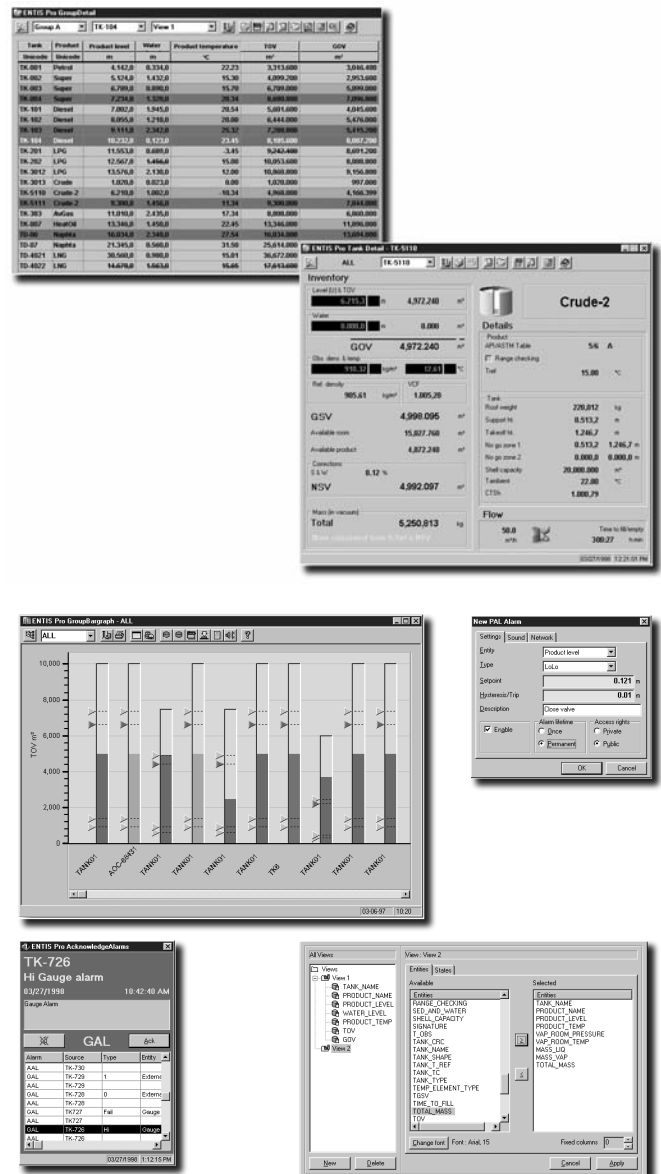

7 Future trends in Tank Gauging Technology

Combining static and dynamic measuring techniques provide a possibility for continuously monitoring physical stock levels on a real-time basis. By reconciling recorded changes in stock levels against actually metered movements, the system can detect and immediately identify any product losses.

Unexpected product movements can then be signaled to the operator by an alarm.

Statistical analysis of static data from the tank gauging system and dynamic data from flow meters could also be used to improve the accuracy of the tank capacity table.

Cross correlation of gauges versus flow meters could further reduce measurement uncertainties. With high accuracy tank gauging instruments combined with powerful computing platforms, automatic reconciliation becomes realistic.

Interfaces to multiple supplier systems, ranging from tank gauging to loading and valve control systems, will be feasible via internationally accepted communication standards.

Fig. 31. Pressurized gas storage facility



8 Summary

A wide range of different tank gauging instruments is available. The employed techniques are more complementary than competitive as each measuring principle has its own advantages. Modern servo and radar gauges have improved considerably. They hardly need any HTG is to be preferred if mass is the desired measurement for inventory and custody transfer.

The costs of any tank gauging system are mainly determined by the cost of installation including field cabling. In upgrading projects, costs depend very much on the possibility of retrofitting existing facilities.

Because of worldwide commercial practice, volume measurement will continue to play an important role.

maintenance and can provide trouble free operation if applied correctly. The possibility of mixed installations with servo, radar, HTG and HIMS provides optimal flexibility and utilizes the capability of each gauging technique.

The combination of volume and mass offers great advantages. A globally accepted measurement standard will probably not be published for several years. Implementation of volume and mass calculations outside the management information-, DCS- or host systems remains preferable. Integrity requirements for volume and mass calculations imposed by the Weight and Measurement authorities are easier to fulfill externally and justify the additional hardware.

Standard field busses may play a decisive role in the direct interface between dedicated Tank Gauging Systems and other systems. However, the quality of the measurements should never be sacrificed for the sake of bus standardization.

9 Literature

- ISO 91.
- ISO/TC28/section 3.
Terms relating to the calculation of oil quantity.
- ASTM Tables 6, 53 and 54.
- API Manual of Petroleum Measurement Standards.
Annex to chapter 1, 'Vocabulary'.
- Enraf publication: Maintaining Safe Tank Storage with Modern Automatic Tank Gauging Systems.
- Enraf publication: An analysis of uncertainties in Tank Gauging Systems.

Fig. 32. A terminal

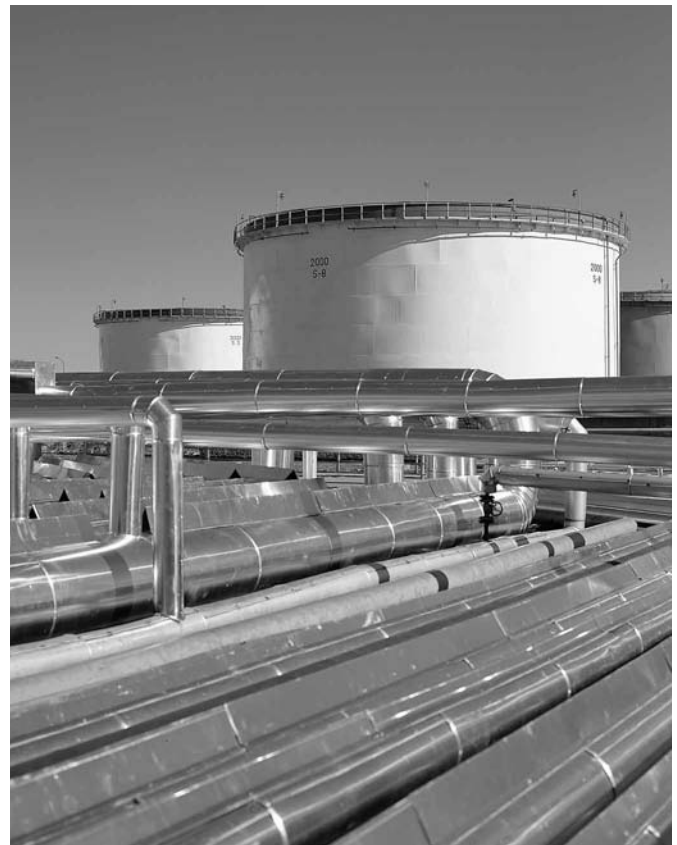

All products from one supplier

AlarmScout and WaterScout

Innovative devices to prevent overflow and spills. AlarmScout detects liquids, slurries, foam as well as interfaces (e.g. oil/water). Also WaterScout can be applied for accurate water/product interface level measurement.

Control Panel Indicator

This remote panel indicator can be used in a control room or pumping facility. It displays liquid level and average liquid temperature. Test and checking commands can easily be given via dedicated soft keys on the front panel.

Portable Enraf Terminal

For safe and comfortable commissioning and instrument configuration even in a hazardous area. This hand-held instrument is provided with an easy to read LCD display and a full ASCII membrane keyboard.

Field Display & Interface

A versatile, EEx approved solid-state field device for display of tank gauging data at ground level, eliminating the need for tank climbing. The FDI provides W&M accepted tank inventory information where needed.

Securiterre

This grounding device takes care of safe loading of flammable products. It helps prevent an explosion due to ignition by electrostatic electricity. Applications includes grounding of road and rail tankers, airplanes, helicopters, barges, tankers, oil drums, etc.

Average temperature gauging

For correct inventory calculations, accurate average liquid temperature is a must. The Multiple Thermosensor Thermometer (MTT) makes use of proven technology and offers the highly efficient temperature parameter for total inventory control.

Hydrostatic tank gauging systems

Unique is the Hybrid Inventory Management System (HIMS), a combination of hydrostatic gauging and a level gauge. Average density is continuously available. A Hydrostatic Tank Gauging (HTG) system is the solution for accurate mass measurement.

Communication Interface Unit, CIU Prime

This multi-functional unit is an interface between the field instruments and the tank inventory management system. The main task of the CIU Prime is scanning the tank gauges. Information becomes available via CIU emulation or MODBUS protocols.

Communication Interface Unit, CIU Plus

The CIU Plus processes data received from a CIU Prime. This results in information including: volume, flow rate and mass, using formulas according to international standards. The information becomes available for higher level systems.

Entis Pro inventory management system

Enraf's CYBER approach to manage liquid inventory. This flexible Windows-NT based system provides superb data for effective tank farm management. With the latest technology, Enraf has gained recognition from official measurement authorities.

Servo tank gauge

This intelligent tank gauge is the fifth generation for liquid storage applications. This instrument is able to detect level, interface level as well as the density of the product. It received certification from leading Weights & Measures authorities.

SmartRadar level gauge

A unique level gauge utilizing the newest technology is the latest development in non-intrusive level measurement. SmartRadar uses Planar Antenna Technology and Advanced Digital Signal Processing to provide superior measuring results.

The complete system from one supplier

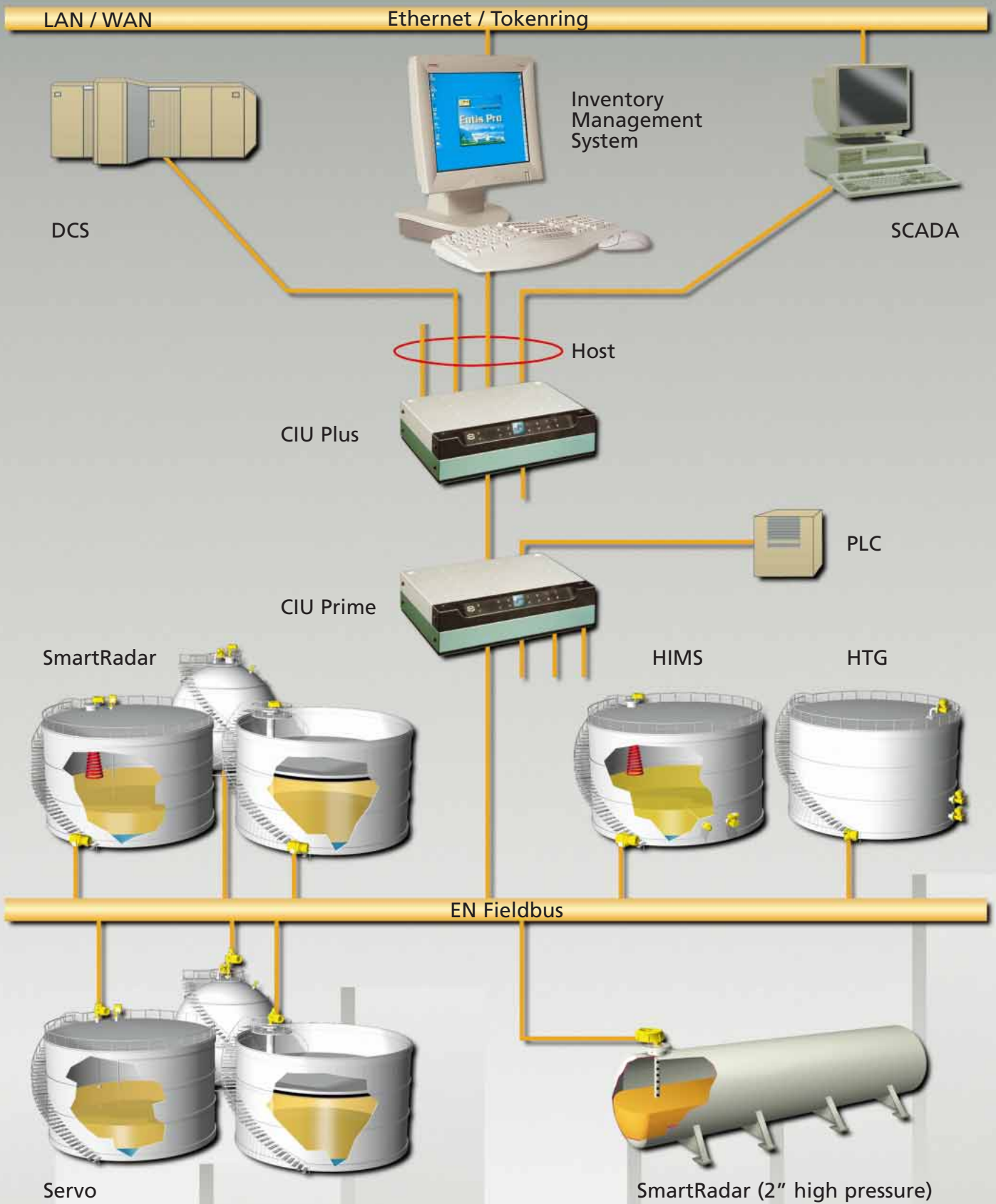



Terminal Automation

Contrec

Tanksystem

Marine Systems

Fluid Technology

Companies

The Netherlands: Enraf Terminal Automation

T +31 (0)15 2701 100, **F** +31 (0)15 270 1111
E info@enraf.nl, **I** www.enraf.com

Australia: Enraf Contrec Ltd.

T +61 3 9804 4200, **F** +61 3 9822 8329
E contrec@contrec.com.au, **I** www.enrafcontrec.com

Switzerland: Enraf Tanksystem SA

T +41 26 91 91 500, **F** +41 26 91 91 505
E info@tanksystem.com, **I** www.enraftanksystem.com

Americas: Enraf Fluid Technology USA Inc.

T +1 770 475 1900, **F** +91 44 281 56 888
E info@us.enraf.com, **I** www.enraffluidtechnology.com

United Kingdom: Enraf Fluid Technology Ltd.

T +44 (0)1329 825 823, **F** +44 (0)1329 825 824
E info@uk.enraf.com, **I** www.enraffluidtechnology.com

France: Enraf Marine Systems

T +33 (0)1 3920 3827, **F** +33 (0)1 3902 2561
E contact@enrafmarine.fr, **I** www.enrafmarine.com

Branch Offices

Americas: Enraf Inc.

T +1 832 467 3422, **F** +1 832 467 3441
E sales@enrafinc.com

China: Enraf Pte. Ltd. (Shanghai Rep. Office)

T +86 21 50367000, **F** +86 21 50367111
E enraf@enraf.com.cn

France: ENRAF S.a.r.l. (Sevran)

T +33 (1) 49 36 20 80, **F** +33 (1) 43 85 26 48
E enrafrance@compuserve.com

France: ENRAF S.a.r.l. (Martigues)

T +33 (4) 42 07 07 69, **F** +33 (4) 42 81 41 81
E gillesbarreau@enraf.fr

Germany: Enraf GmbH

T +49 (0)212 58 750, **F** +49 (0)212 58 7549
E info@enraf.de

India: Enraf India Pvt. Ltd. (Mumbai)

T +91 22 285 23 990, **F** +91 22 285 22 264
E enraf@enraf.in

India: Enraf India Pvt. Ltd. (Chennai)

T +91 44 281 56 999, **F** +91 44 281 56 888
E enraf@enraf.in

Middle East: Enraf Middle East

T +973 17 456 187, **F** +973 17 456 133
E salesbahrain@enraf.nl

Russia: Enraf B.V. (Moscow Rep. Office)

T/F +7 (0)95 788 0713, **T/F** +7 (0)95 788 0691
E enrafrus@co.ru

Singapore: Enraf Pte. Ltd .

T +65 676 94 857, **F** +65 683 67 496
E enraf@enraf.com.sg

United Kingdom: Enraf Ltd.

T +44 (0)1329 825 823, **F** +44 (0)1329 825 824
E info@enraf.co.uk